



DATACENTER
AUTOMATION



ASSET
MANAGEMENT



SMART
CABLING



NGN
MIGRATION



DSL
QUALIFICATION



RECORDS
VERIFICATION

Cluster Design

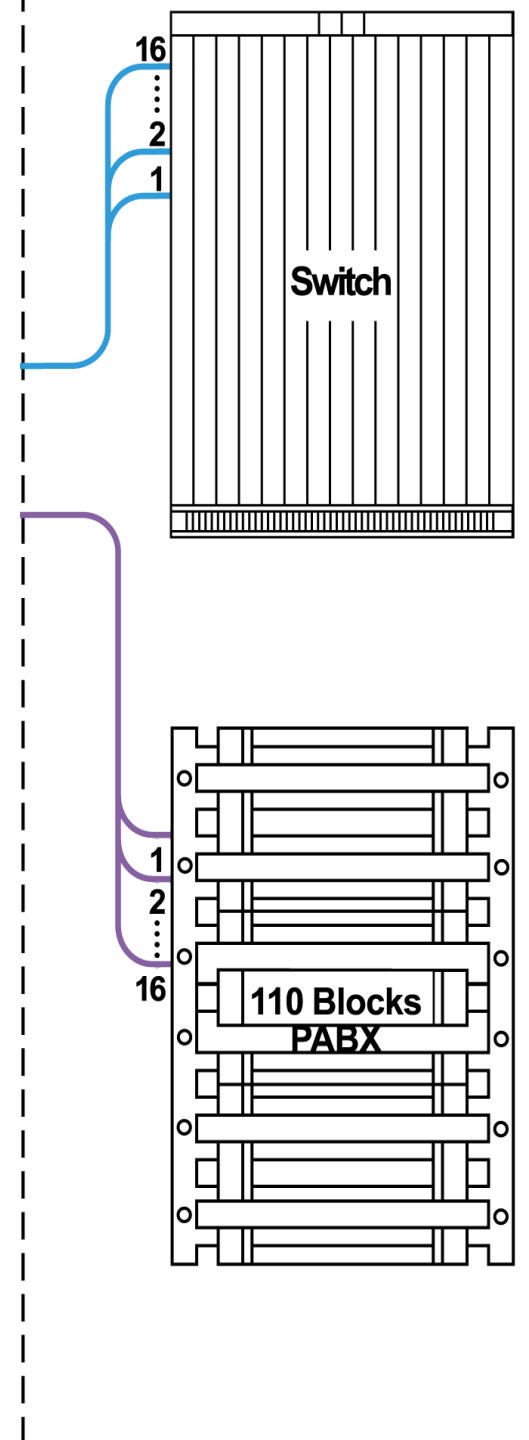
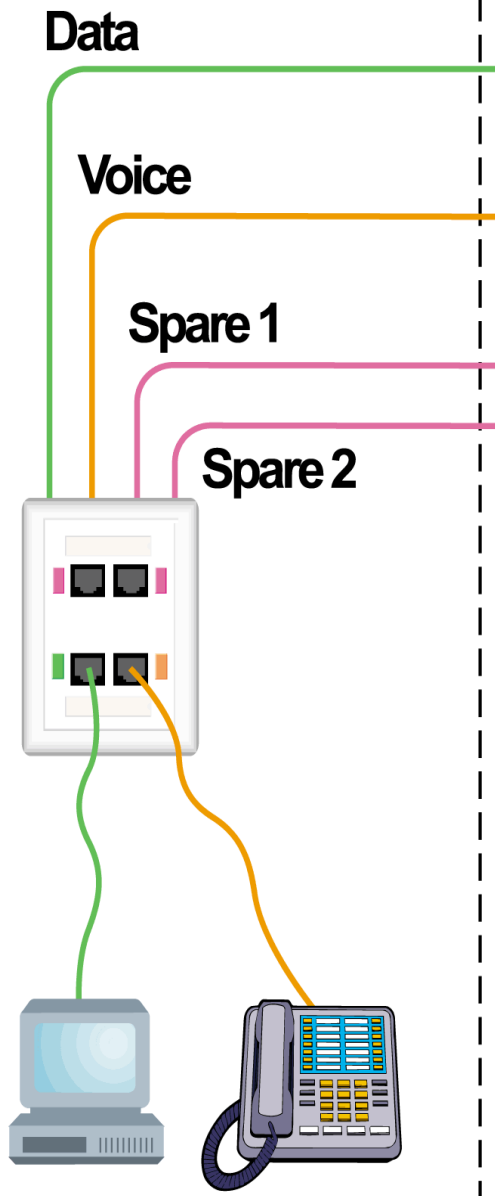

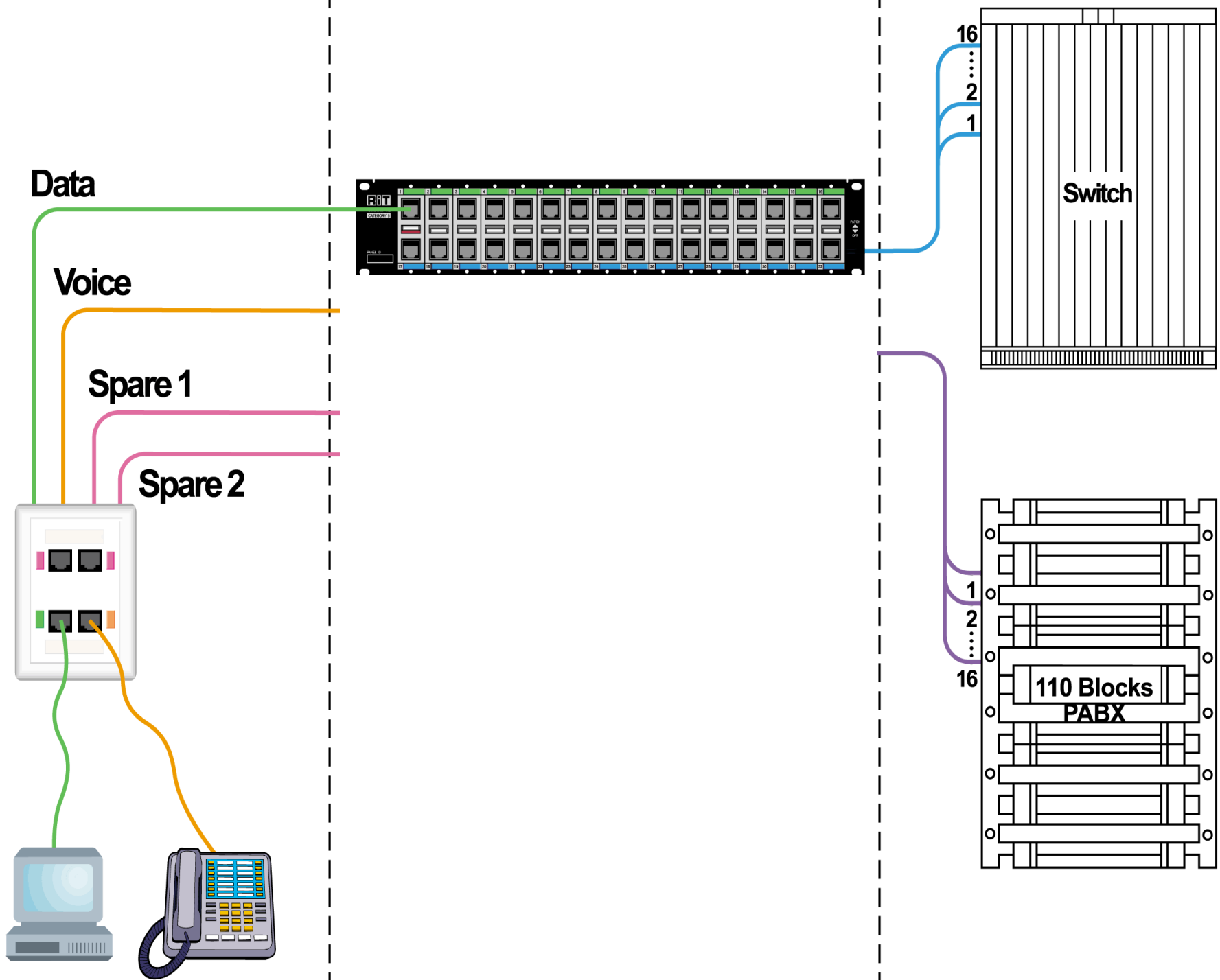

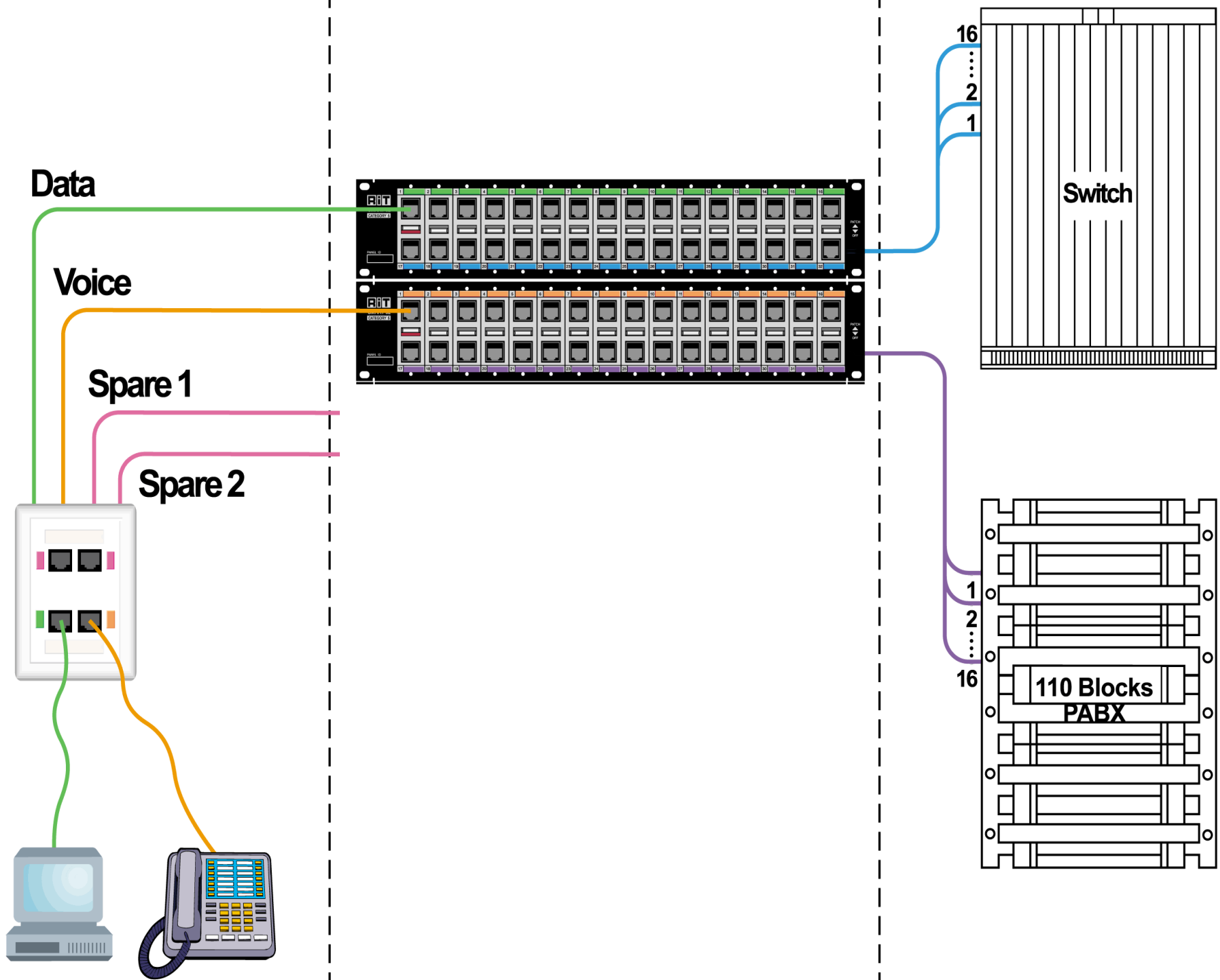

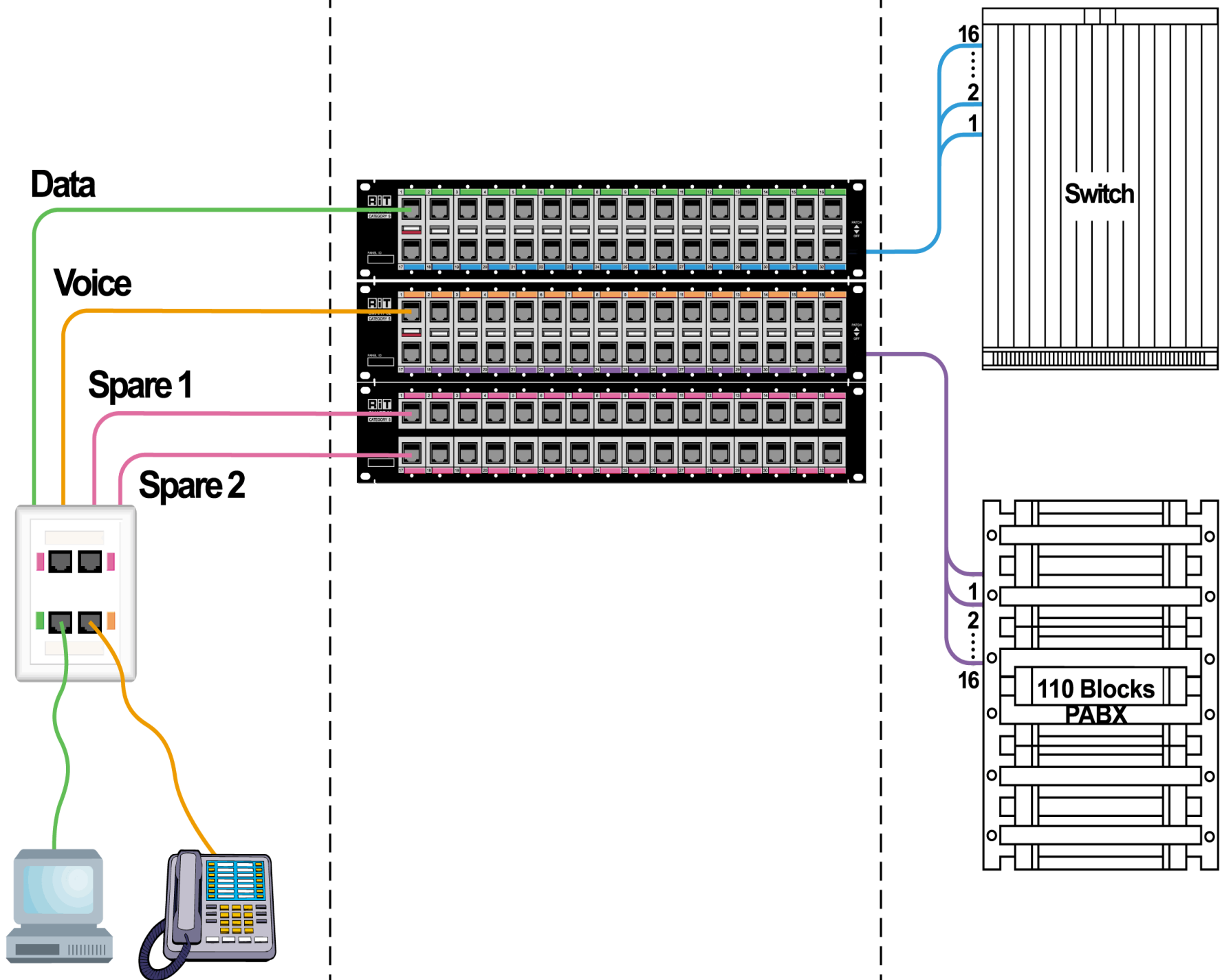

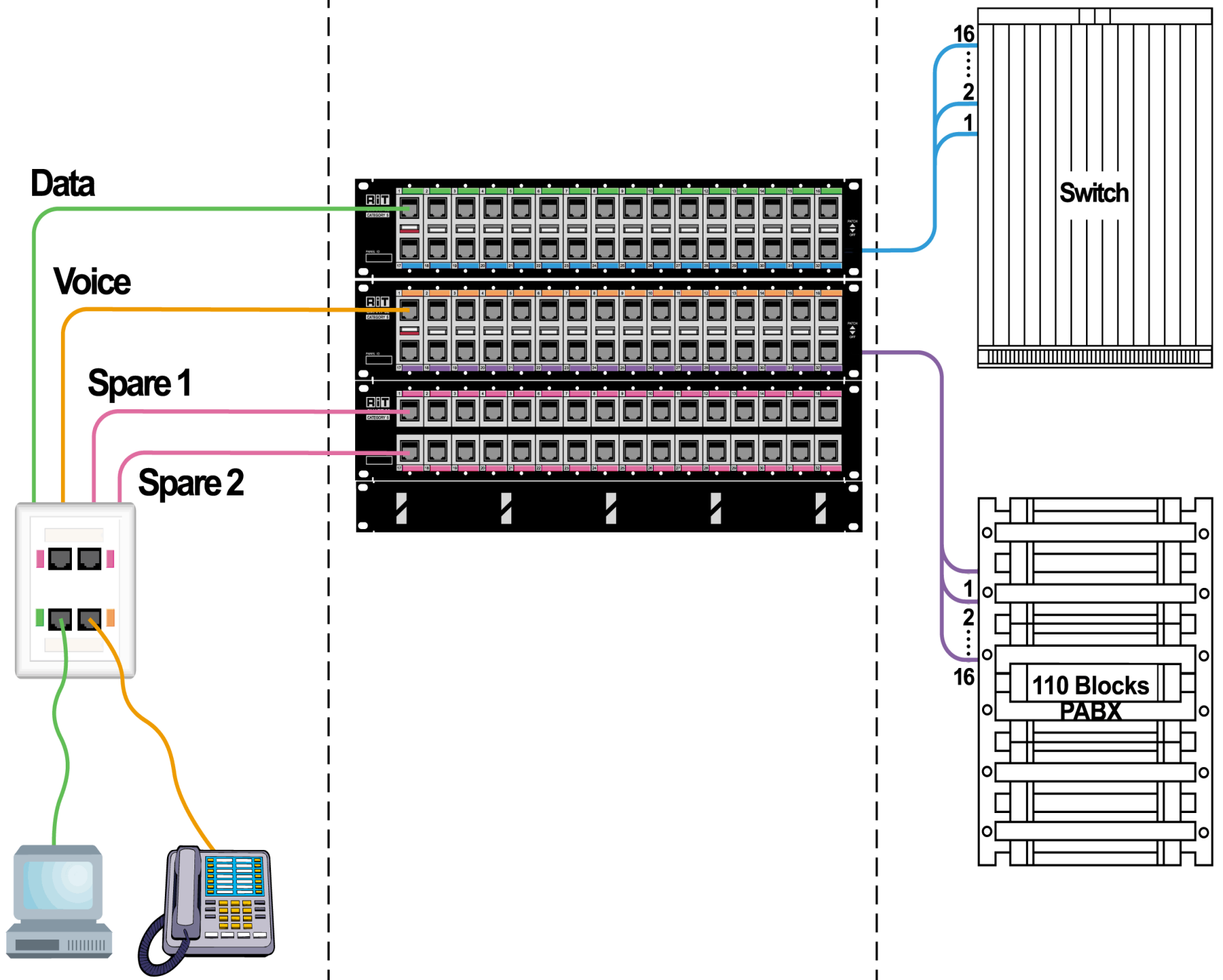

One Cluster is...

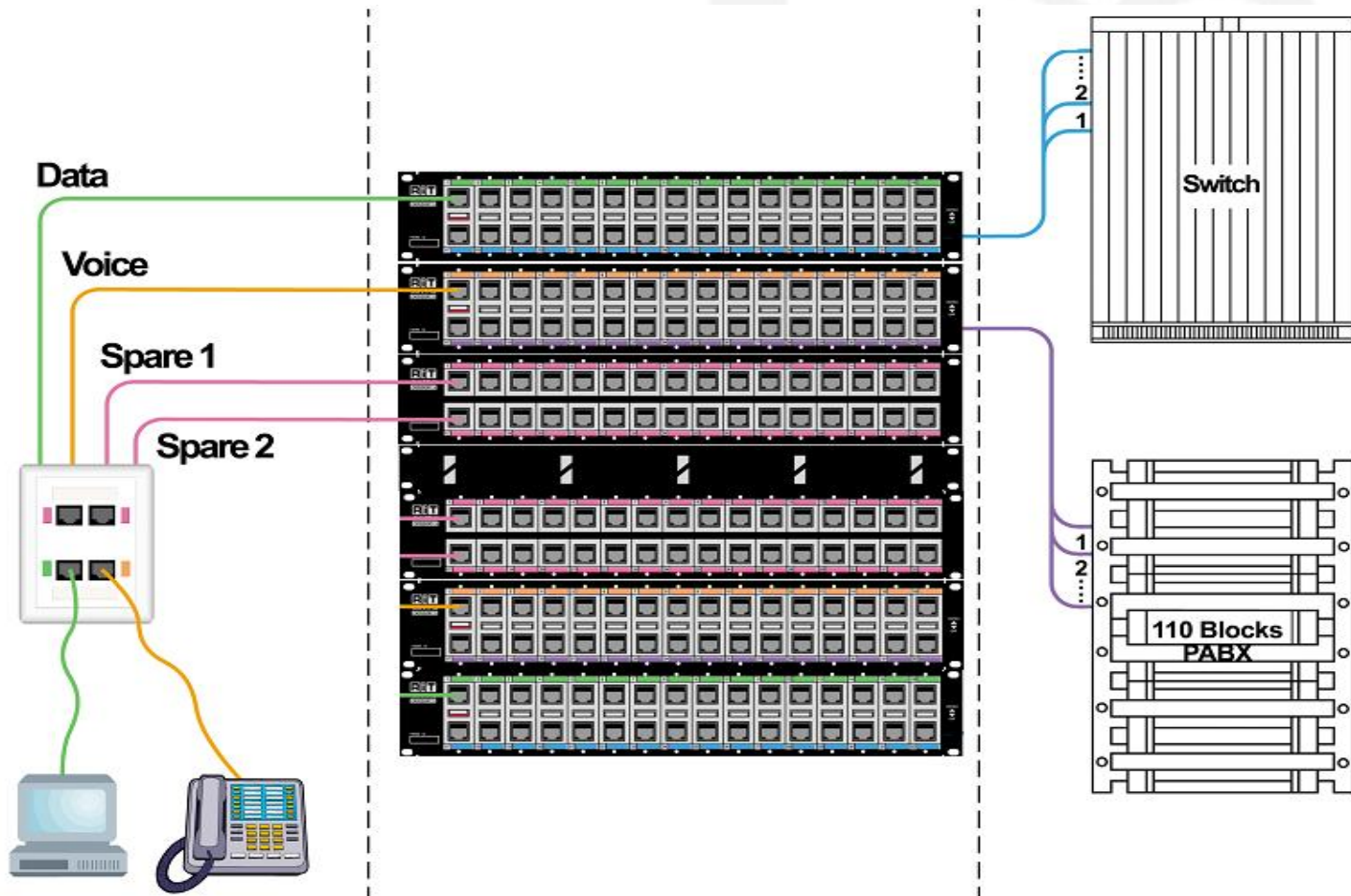

Cluster design advantage

- 50% – 70% less patch chords
- Very short patch chords – if required
- Flexible and open to upgrades
- Blank panel facilitates simple future growth
- Simplified MAC
- PatchView ready
- Lower overall cost

